

THIS DRAWING IS UNPUBLISHED. RELEASED FOR PUBLICATION
 © COPYRIGHT BY TYCO ELECTRONICS CORPORATION. ALL RIGHTS RESERVED.

LOC	DIST	REVISIONS					
		P	LTR	DESCRIPTION	DATE	DWN	APVD
G	14		H	REV PER 0G3A-0640-04	16AUG04	JR	TM

AMP WIRE RANGE	Listed FILE E13288	LR7189 Certified
22-16 AWG SOLID OR STRANDED	22-16 AWG SOLID OR STRANDED	22-16 AWG SOLID OR STRANDED

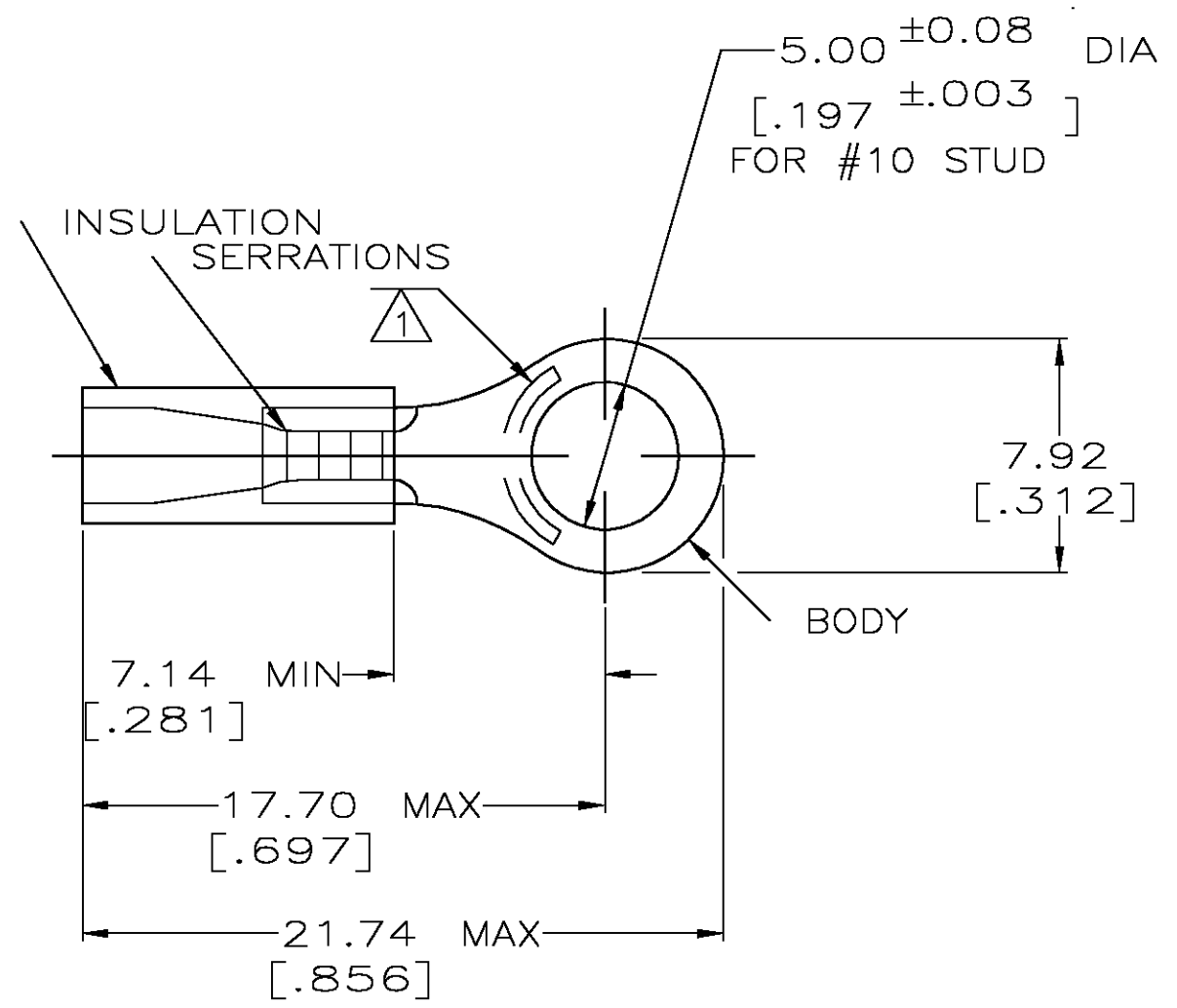

- 1 STAMP AMP 22-18* 1-2 APPROX AS SHOWN
22-16 TERMINALS ARE STAMPED 22-18 IN
ACCORDANCE WITH MILITARY SPEC MIL-T-7928
COMMERCIAL WIRE RANGE IS 22-16
- 2 WIRE INSULATION DIA: 2.03-3.18 [.080-.125]
- 3 TONGUE MATERIAL THK: 0.79^{±0.05} [.031^{±.002}]
- 4 MATERIAL: BODY - CU PER ASTM B152
SLEEVE - PVC, COLOR - RED

100	LOOSE PC,BOX	8-32952-1
5000	ON TAPE, REEL	2-32952-1
1000	LOOSE PIECE	32952
QTY	PACKAGE TYPE	PART NO.

AMP INCORPORATED CUSTOMER SERVICE SYSTEMS		MAX RECOMMENDED OPERATING TEMPERATURE: 105°C [221°F]	THIS DRAWING IS A CONTROLLED DOCUMENT.		DWN DK SCHRUM 08/06/92	Tyco Electronics Corporation Harrisburg, Pa 17105-3608			
FOR ADDITIONAL PRODUCT INFORMATION OR COPIES OF DRAWINGS AND TECHNICAL DOCUMENTS	PRODUCT INFORMATION CENTER 1-800-522-6752	VOLTAGE RATING: 600V MAX (1000V FIXTURE OR SIGN)	DIMENSIONS: MM[INCHES]	TOLERANCES UNLESS OTHERWISE SPECIFIED:	CHK RE HERSEY 11/10/92	NAME M BARNABA			
FOR APPLICATION TOOLING INFORMATION	TOOLING ASSISTANCE CENTER 1-800-722-1111	CIRCULAR MIL AREA: 0.26-1.65mm² [509-3260] SOLID OR STRANDED		0 PLC ± - 1 PLC ± - 2 PLC ± 0.20[.008] 3 PLC ± - 4 PLC ± - ANGLES ± -	APVD M BARNABA 11/10/92	PRODUCT SPEC UL 486A			
FOR ORDER ENTRY	1-800-526-5142	THIS DRAWING IS A CONTROLLED DOCUMENT FOR AMP INCORPORATED. IT IS SUBJECT TO CHANGE AND THE CONTROLLING ENGINEERING ORGANIZATION SHOULD BE CONTACTED FOR THE LATEST REVISION.	MATERIAL -4	FINISH TIN PER ASTM B545	APPLICATION SPEC -	SIZE A3	CAGE CODE 00779	DRAWING NO C-32952	RESTRICTED TO -
CUSTOMER DRAWING					SCALE 4:1	SHEET 1	OF 1	REV H	